

The **NORCHEM AnCAT Model 058GS-600SD** automatic liquid polymer system is designed to process up to 25.0 GPH of a neat liquid polymer and deliver 1.0 to 16.0 GPM (60 to 960 GPH) of a nominal 0.1 to 2.0% aqueous polymer solution. The 058GS-600SD system is modular in design consisting of a liquid polymer injection module and booster module assembly.

AnCAT MODEL 058GS-600SD LIQUID POLYMER SYSTEM SPECIFICATIONS

FRAME:	BASE: CONSTRUCTION:	24" W x 24" L x 26" H 304SS BASE
INJECTION MODULE:	PUMP: DRIVE: MOTOR: CAPACITY:	ROTARY-GEAR-TYPE, 316 STAINLESS STEEL POSITIVE TORQUE TRANSMISSION, 4:1 GEAR REDUCTION ¼ HP, 1725 RPM, TENV, CONTINUOUS DUTY NEAT POLYMER FLOWRATE: 4.2 TO 25.0 GPH (100 TO 600 GPD)
BOOSTER MODULE:	PUMP: DRIVE: MOTOR: DISCHARGE:	CENTRIFUGAL-TYPE, CAST IRON, MODIFIED FOR POLYMERS CLOSE-COUPLED .75 HP, 3450 RPM, CONTINUOUS DUTY, ODP 10 – 60 PSI 1.0 – 16.0 GPM
SOLUTION OUTPUT:	PRIMARY FLOW: SECONDARY FLOW: TOTAL FLOW:	3.0 – 8.0 GPM (480 GPH) 0.0 – 8.0 GPM (480 GPH) 3.0 – 16.0 GPM (960 GPH)
CONCENTRATION:	SOLUTION:	PRIMARY 0.2 – 2.0% VOLUME ON VOLUME TOTAL 0.1 – 1.0% VOLUME ON VOLUME
UTILITIES:	ELECTRICAL: WATER:	120/1/60 20 AMPS 40 – 100 PSI 25 GPM CLEAN SOURCE
CONTROLS:	CONTROLLER: LOW WATER: LOW POLYMER:	(OPTIONAL) NEMA 4X W/ TOUCHPAD, POLYMER RATIO, REMOTE START/STOP, POLYMER PUMP READOUT, WATER RATIO, PRIMARY AND SECONDARY FLOW READOUTS, REMOTE SETPOINT AND DOSING CONTROL, AUTO CALIBRATION AND ALARMS (OPTIONAL) PISTON FLOW SENSOR WITH AUTO RESTART OR MANUAL RESET (OPTIONAL) OPTICAL SENSORS WITH ADJUSTABLE RANGE 0.15 – 2.0% CONCENTRATION

ENGINEERING SPECIFICATIONS:

AnCAT Model 058GS-600SD shall be provided to rapidly dilute, activate and feed emulsion, dispersion and solution polymers at 960 GPH of polymer solution at concentrations to 2%. The system shall contain a four step controlled energy hydraulic circuit which instantaneously dilutes and blends the polymer to it's most efficient state for use in the process. The unit shall be designed with full pressure-controlled, inline inversion capability and shall not be limited by a minimum retention time restriction. The polymer system shall be capable of providing a 15 – 20 PSI pressure boost and shall not rely on available inlet water pressure to discharge the polymer solution product. The system shall be modular in design and shall consist of a polymer injection module, booster module, premix manifold assembly, inlet water solenoid valve, primary and secondary inlet water flowmeter, primary and secondary inlet water flow controllers, proportioning pressure regulator to balance primary and secondary flow circuits, mixing pressure regulator adjustable from 10 to 70 PSI, mixing circuit pressure gauge and inlet water throttling valve.

PLAN & ELEVATION

05GSSD_DIM

AnCAT 05GSD-SERIES

(TYPICAL TO ALL 054GSD AND 058GSD SYSTEMS)

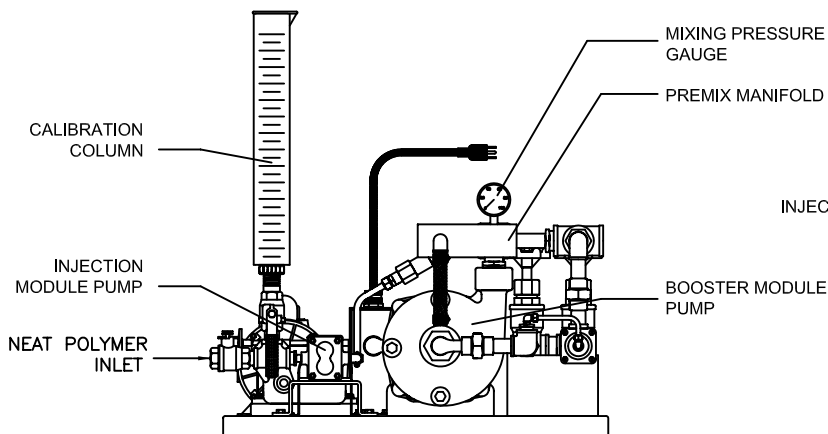

FRONT VIEW

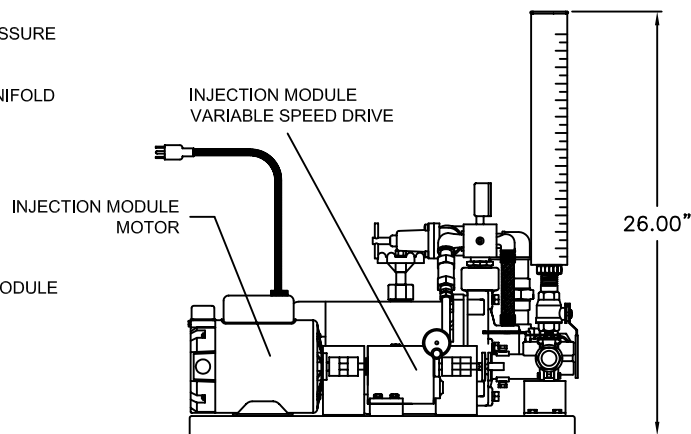

LEFT END VIEW

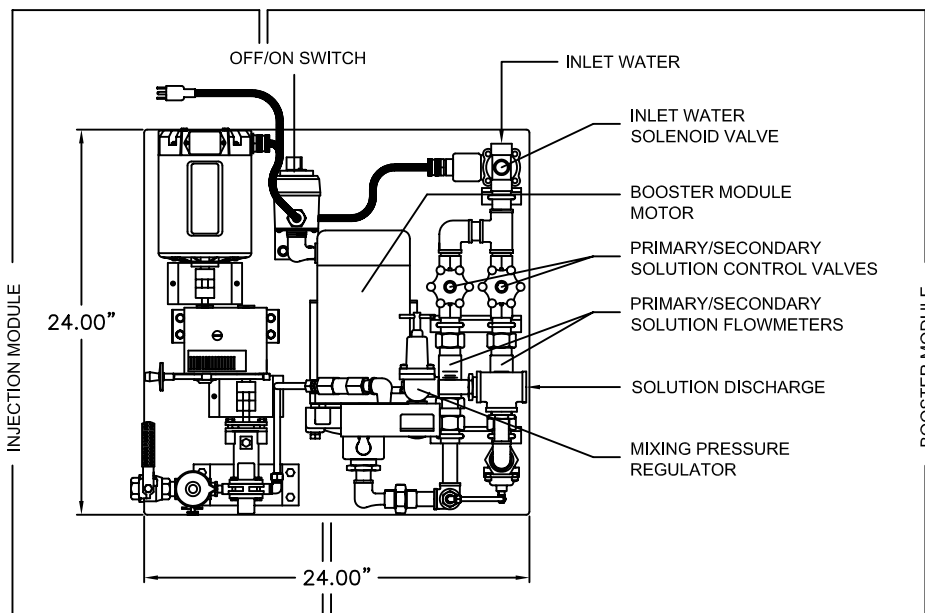

PLAN VIEW

NORCHEM INC.

ELECTRICAL SCHEMATIC

AnCAT 05GSD-SERIES

05GSSD_ELE

(TYPICAL FOR ALL 054GSD AND 058GSD SYSTEMS)

INCOMING POWER
115 VAC/1 PH/60 HZ

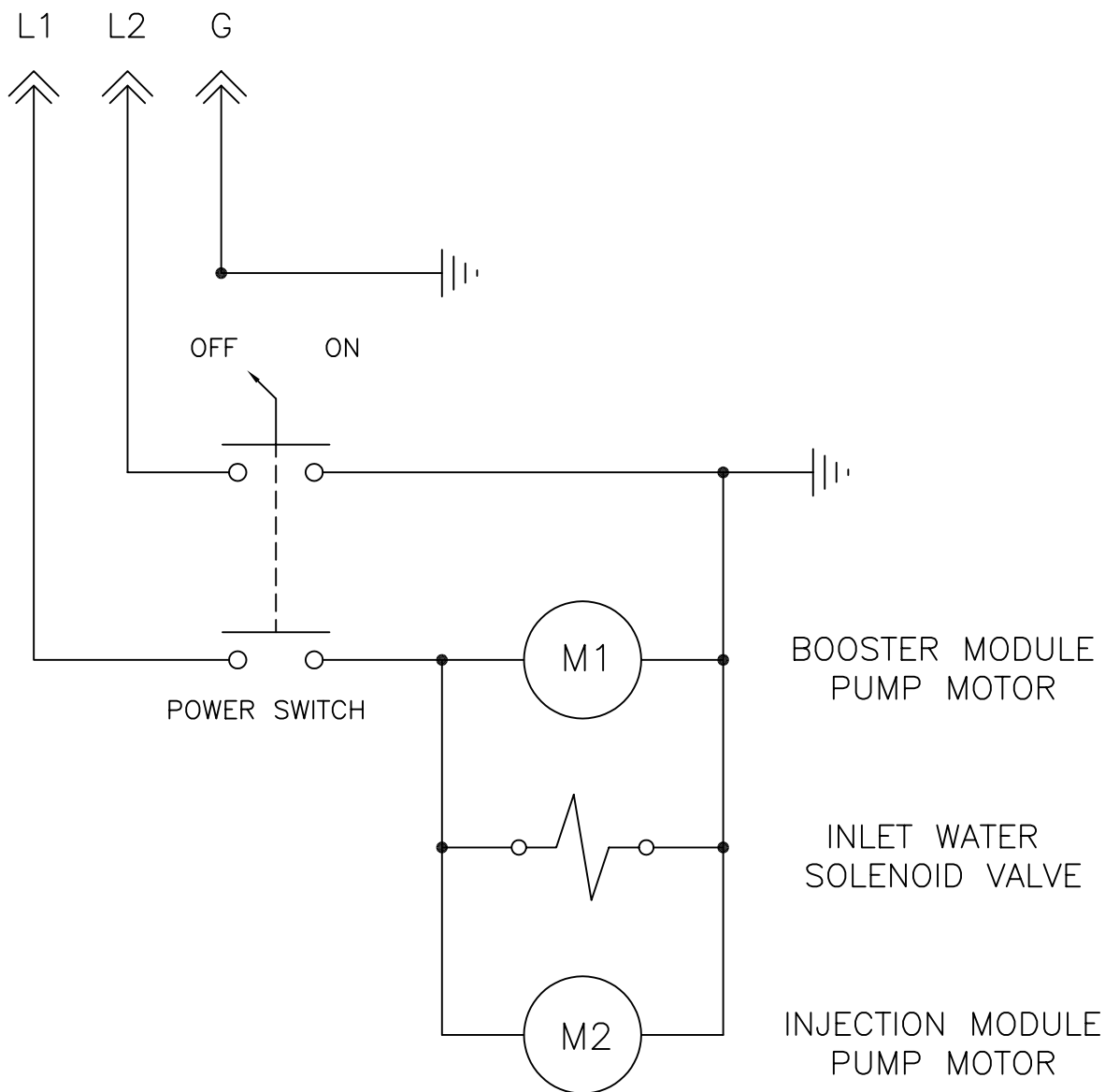

NORCHEM INC.

(TYPICAL TO ALL 054GSD AND 058GSD SYSTEMS)

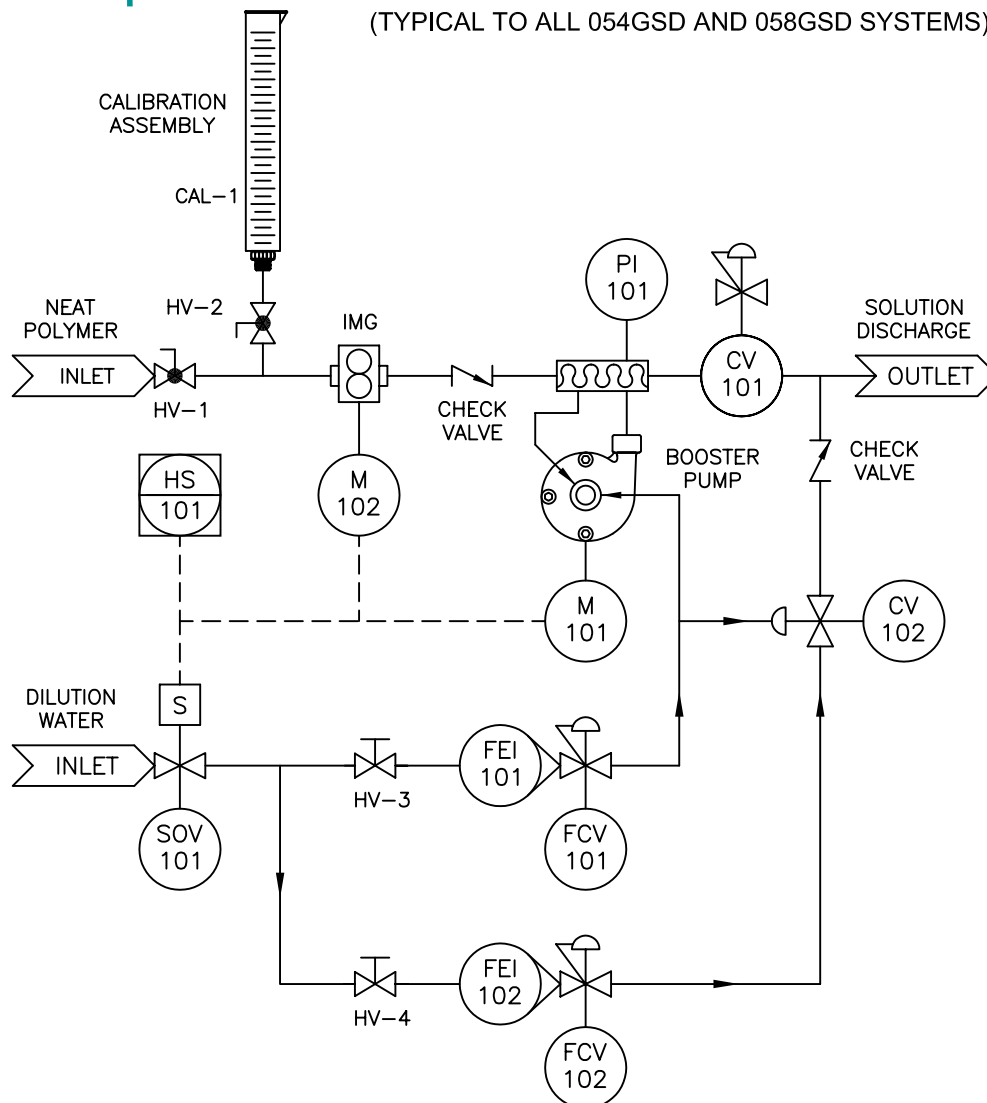

LEGEND

HV-1	POLYMER SUPPLY SHUTOFF HAND VALVE
HV-2	CALIBRATION ASSEMBLY ISOLATION HAND VALVE
HV-3	PRIMARY DILUTION WATER THROTTLING VALVE
HV-4	SECONDARY DILUTION WATER THROTTLING VALVE
CAL-1	CALIBRATION CYLINDER
IMG	INJECTION MODULE GEAR PUMP
PI-101	MIXING PRESSURE GAUGE
M-101	POLYMER INJECTION PUMP MOTOR
M-102	DILUTION WATER INLET SOLENOID VALVE
SOV-1	DILUTION WATER INLET SOLENOID VALVE
CV-101	MIXING PRESSURE CONTROL VALVE
CV-102	SECONDARY DILUTION EQUAIZATION VALVE
FEI-101	PRIMARY DILUTION WATER INDICATING FLOW METER
FEI-102	SECONDARY DILUTION WATER INDICATING FLOWMETER
FCV-101	PRIMARY DILUTION WATER CONTROL REGULATOR
FCV-102	SECONDARY DILUTION FLOW CONTROL REGULATOR
HS-101	OFF/ON SWITCH