

The **NORCHEM AnCAT Model 058PC-144** automatic liquid polymer system is designed to process up to 6.0 GPH of a neat liquid polymer and deliver 1.0 to 8.0 GPM (60 to 480 GPH) of a nominal 0.1 to 2.0% aqueous polymer solution. The 058PC-144 system is modular in design consisting of a liquid polymer injection module and booster module assembly.

**AnCAT MODEL 058PC-144 LIQUID POLYMER SYSTEM SPECIFICATIONS**

<b>FRAME:</b>	<b>BASE:</b>	<b>24" W x 24" L x 26" H</b>
	<b>CONSTRUCTION:</b>	<b>304SS BASE</b>
<b>INJECTION MODULE:</b>	<b>PUMP:</b>	<b>PROGRESSIVE-CAVITY-TYPE, 316 SS ROTOR, VITON STATOR</b>
	<b>DRIVE:</b>	<b>POSITIVE TORQUE TRANSMISSION, 4:1 GEAR REDUCTION</b>
	<b>MOTOR:</b>	<b>¼ HP, 1725 RPM, TENV, CONTINUOUS DUTY</b>
	<b>CAPACITY:</b>	<b>NEAT POLYMER FLOWRATE: 1.0 TO 6.0 GPH (24 TO 144 GPD)</b>
<b>BOOSTER MODULE:</b>	<b>PUMP:</b>	<b>CENTRIFUGAL-TYPE, CAST IRON, MODIFIED FOR POLYMERS</b>
	<b>DRIVE:</b>	<b>CLOSE-COUPLED</b>
	<b>MOTOR:</b>	<b>.75 HP, 3450 RPM, CONTINUOUS DUTY, ODP</b>
	<b>DISCHARGE:</b>	<b>10 – 60 PSI 1.0 – 8.0 GPM</b>
<b>SOLUTION OUTPUT:</b>	<b>PRIMARY FLOW:</b>	<b>3.0 – 8.0 GPM (480 GPH)</b>
	<b>SECONDARY FLOW:</b>	<b>NONE</b>
	<b>TOTAL FLOW:</b>	<b>3.0 – 8.0 GPM (480 GPH)</b>
<b>CONCENTRATION:</b>	<b>SOLUTION:</b>	<b>PRIMARY 0.2 – 2.0% VOLUME ON VOLUME TOTAL 0.2 – 2.0% VOLUME ON VOLUME</b>
<b>UTILITIES:</b>	<b>ELECTRICAL:</b>	<b>120/1/60 20 AMPS</b>
	<b>WATER:</b>	<b>40 – 100 PSI 25 GPM CLEAN SOURCE</b>
<b>CONTROLS:</b>	<b>CONTROLLER:</b>	<b>(OPTIONAL) NEMA 4X W/ TOUCHPAD, POLYMER RATIO, REMOTE START/STOP, POLYMER PUMP READOUT, WATER RATIO, PRIMARY AND SECONDARY FLOW READOUTS, REMOTE SETPOINT AND DOSING CONTROL, AUTO CALIBRATION AND ALARMS</b>
	<b>LOW WATER:</b>	<b>(OPTIONAL) FLOW SENSOR WITH AUTO RESTART OR MANUAL RESET</b>
	<b>LOW POLYMER:</b>	<b>(OPTIONAL) OPTICAL SENSORS WITH ADJUSTABLE RANGE 0.15 – 2.0% CONCENTRATION</b>

**ENGINEERING SPECIFICATIONS:**

**AnCAT Model 058PC-144** shall be provided to rapidly dilute, activate and feed emulsion, dispersion and solution polymers at 480 GPH of polymer solution at concentrations to 2%. The system shall contain a four step controlled energy hydraulic circuit which instantaneously dilutes and blends the polymer to it's most efficient state for use in the process. The unit shall be designed with full pressure-controlled, inline inversion capability and shall not be limited by a minimum retention time restriction. The polymer system shall be capable of providing a 15 – 20 PSI pressure boost and shall not rely on available inlet water pressure to discharge the polymer solution product. The system shall be modular in design and shall consist of a polymer injection module, booster module, premix manifold assembly, inlet water solenoid valve, primary and secondary inlet water flowmeter, primary and secondary inlet water flow controllers, proportioning pressure regulator to balance primary and secondary flow circuits, mixing pressure regulator adjustable from 10 to 70 PSI, mixing circuit pressure gauge and inlet water throttling valve.

# PLAN & ELEVATION

05PC\_DIM

# AnCAT 05PC-SERIES

(TYPICAL TO ALL 054PC AND 058PC SYSTEMS)

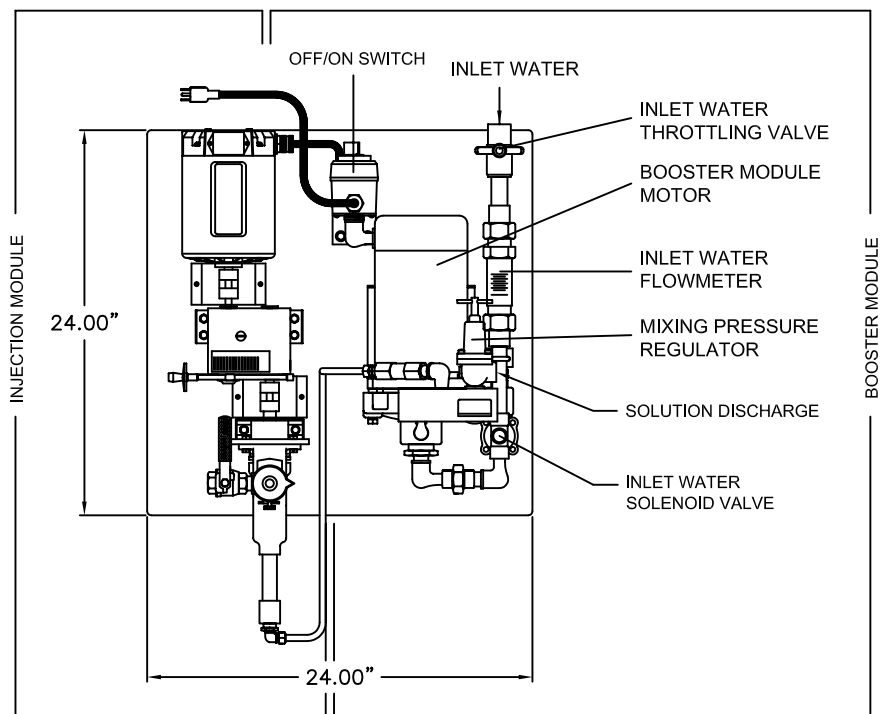
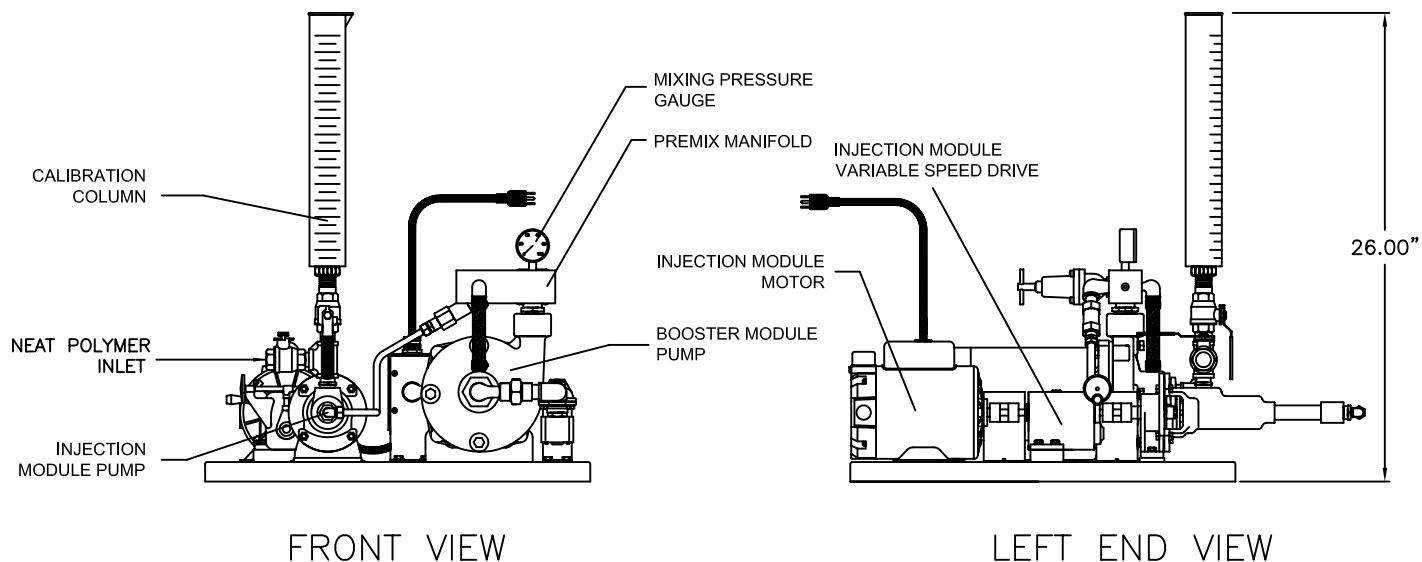

PLAN VIEW

# NORCHEM INC.

# ELECTRICAL SCHEMATIC

05PC\_ELE

# AnCAT 05PC-SERIES

(TYPICAL TO ALL 054PC AND 058PC SYSTEMS)

INCOMING POWER  
115 VAC/1 PH/60 HZ

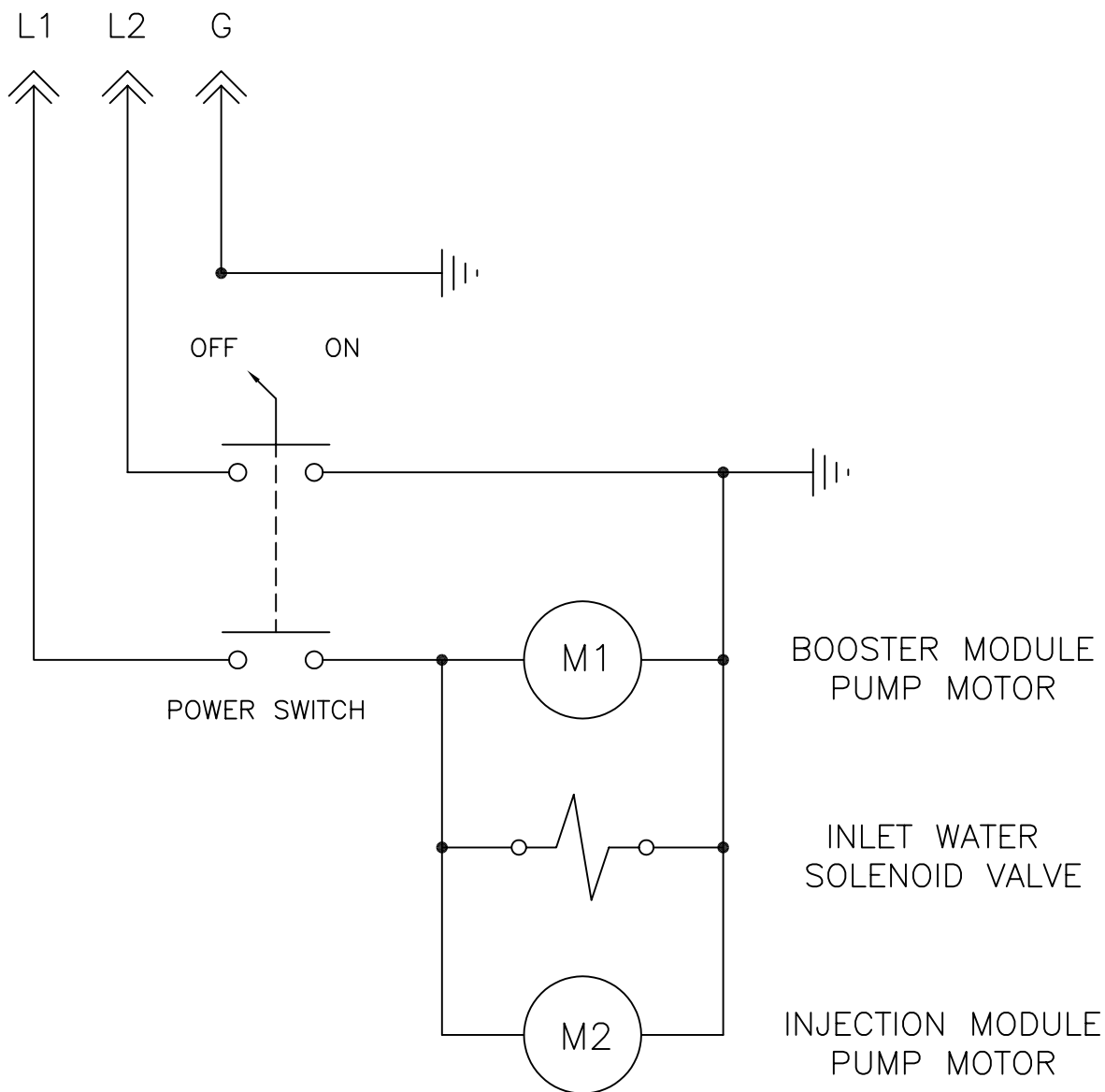

# NORCHEM INC.

(TYPICAL TO ALL 054PC AND 058PC SYSTEMS)

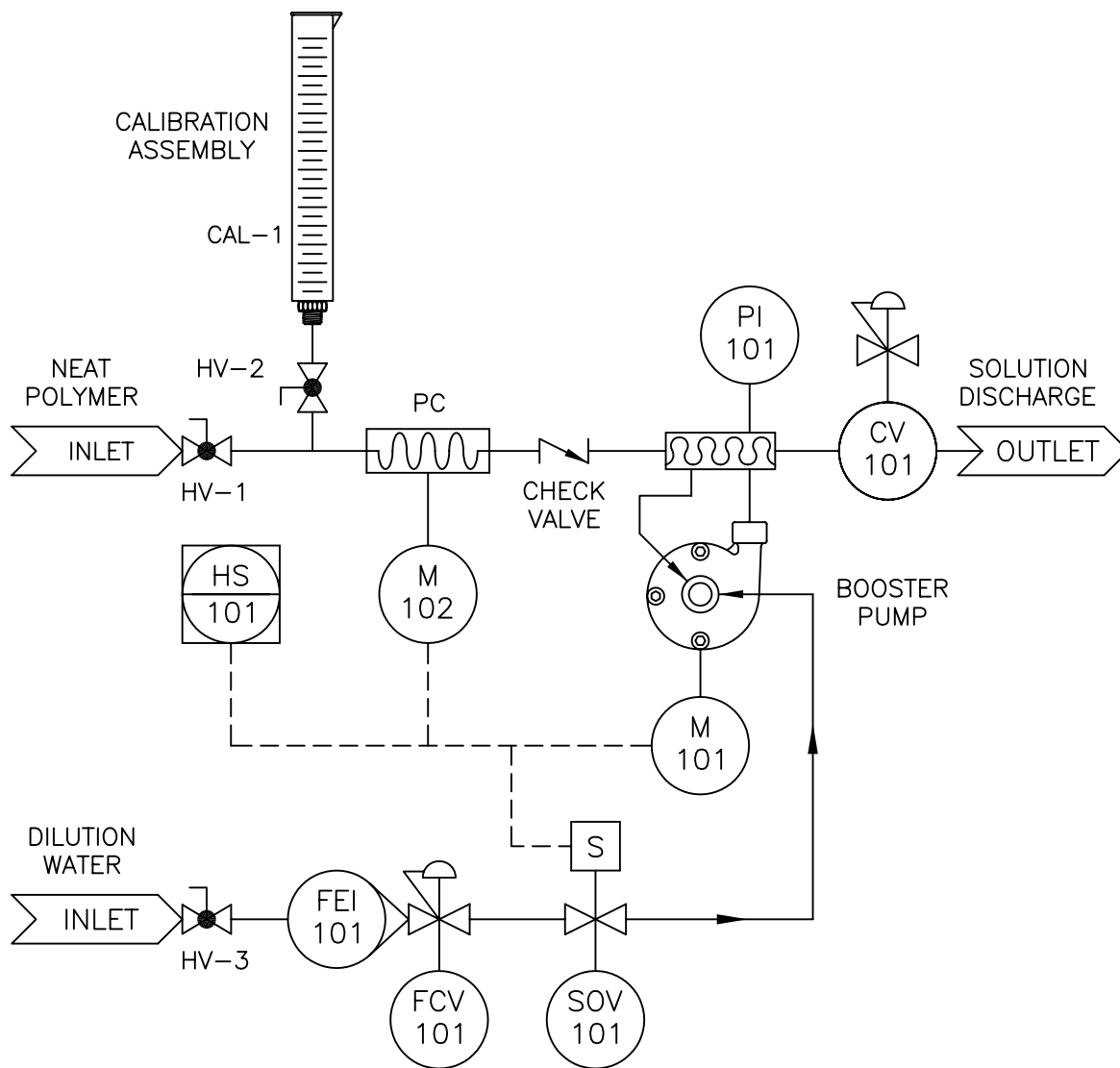

**LEGEND**

- |         |   |
|---------|---|
| HV-1    | POLYMER SUPPLY SHUTOFF HAND VALVE         |
| HV-2    | CALIBRATION ASSEMBLY ISOLATION HAND VALVE |
| HV-3    | INLET WATER THROTTLING VALVE              |
| CAL-1   | CALIBRATION CYLINDER                      |
| PC      | INJECTION MODULE PROGRESSIVE CAVITY PUMP  |
| PI-101  | MIXING PRESSURE GAUGE                     |
| M-101   | BOOSTER PUMP MOTOR                        |
| M-102   | POLYMER INJECTION PUMP MOTOR              |
| SOV-1   | DILUTION WATER INLET SOLENOID VALVE       |
| CV-101  | MIXING PRESSURE CONTROL VALVE             |
| FEI-101 | DILUTION WATER INDICATING FLOW METER      |
| FCV-101 | DILUTION WATER FLOW CONTROL REGULATOR     |
| HS-101  | OFF/ON SWITCH                             |