

The **NORCHEM Sharpshooter Model 848** liquid polymer system is designed to process up to 2.0 GPH of a neat liquid polymer and deliver 1.0 to 8.0 GPM (60 to 480 GPH) of a nominal 0.1 to 2.0% aqueous polymer solution. The Sharpshooter 848 system is modular in design consisting of a liquid polymer injection module and booster module assembly.

SHARPSHOOTER MODEL 848 LIQUID POLYMER SYSTEM SPECIFICATIONS

FRAME:	SIZE: CONSTRUCTION:	16" W x 20" L x 30" H MILD STEEL, DuPONT IMRON POLYURETHANE COATING
INJECTION MODULE:	PUMP: DRIVE: CAPACITY:	DIAPHRAGM-TYPE, HIGH VISCOSITY ENCAPSULATED SOLENOID PULSE DRIVE NEAT POLYMER FLOWRATE 0.0 – 2.0 GPH (48 GPD)
BOOSTER MODULE:	PUMP: DRIVE: MOTOR: DISCHARGE:	CENTRIFUGAL-TYPE, CAST IRON, MODIFIED FOR POLYMERS CLOSE-COUPLED .75 HP, 3450 RPM, CONTINUOUS DUTY, ODP 10 – 60 PSI 1.0 – 8.0 GPM
SOLUTION OUTPUT:	PRIMARY FLOW: SECONDARY FLOW: TOTAL FLOW:	3.0 – 8.0 GPM (480 GPH) NONE 3.0 – 8.0 GPM (480 GPH)
CONCENTRATION:	SOLUTION:	PRIMARY 0.2 – 2.0% VOLUME ON VOLUME TOTAL 0.2 – 2.0% VOLUME ON VOLUME
UTILITIES:	ELECTRICAL: WATER:	120/1/60 20 AMPS 40 – 100 PSI 25 GPM CLEAN SOURCE

ENGINEERING SPECIFICATIONS:

Sharpshooter Model 848 shall be provided to rapidly dilute, activate and feed emulsion, dispersion and solution polymers at 480 GPH of polymer solution at concentrations to 2%. The system shall contain a four step controlled energy hydraulic circuit which instantaneously dilutes and blends the polymer to it's most efficient state for use in the process. The unit shall be designed with full pressure-controlled, inline inversion capability and shall not be limited by a minimum retention time restriction. The polymer system shall be capable of providing a 15 – 20 PSI pressure boost and shall not rely on available inlet water pressure to discharge the polymer solution product. The system shall be modular in design and shall consist of a polymer injection module, booster module, premix manifold assembly, inlet water solenoid valve, primary and secondary inlet water flowmeter, primary and secondary inlet water flow controllers, proportioning pressure regulator to balance primary and secondary flow circuits, mixing pressure regulator adjustable from 10 to 70 PSI, mixing circuit pressure gauge and inlet water throttling valve.

PLAN & ELEVATION

SHARPSHOOTER

SHP_DIM

(TYPICAL TO ALL SHARPSHOOTER SYSTEMS)

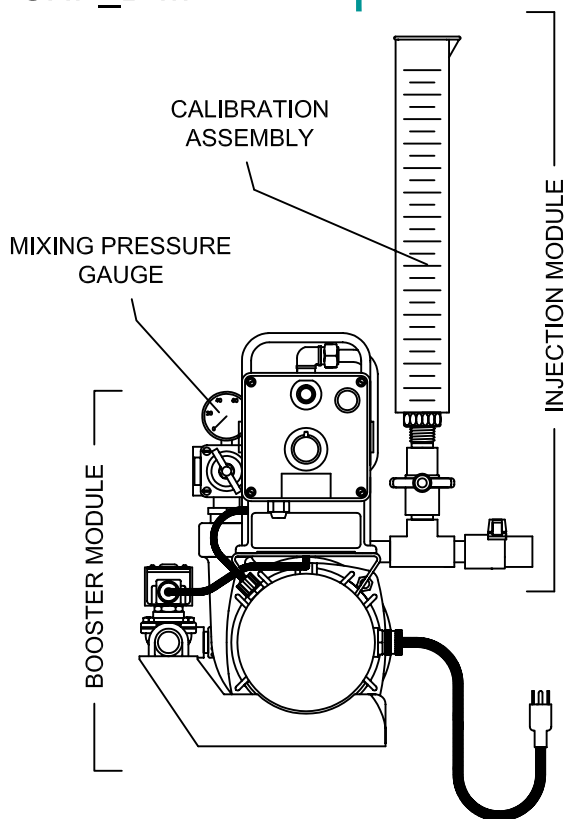

FRONT VIEW

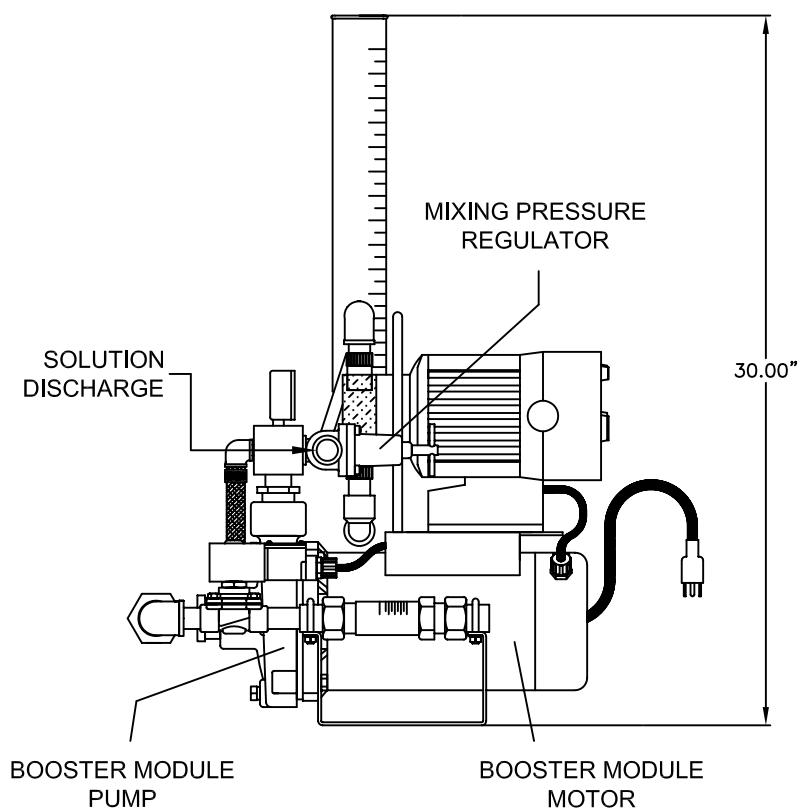

LEFT END VIEW

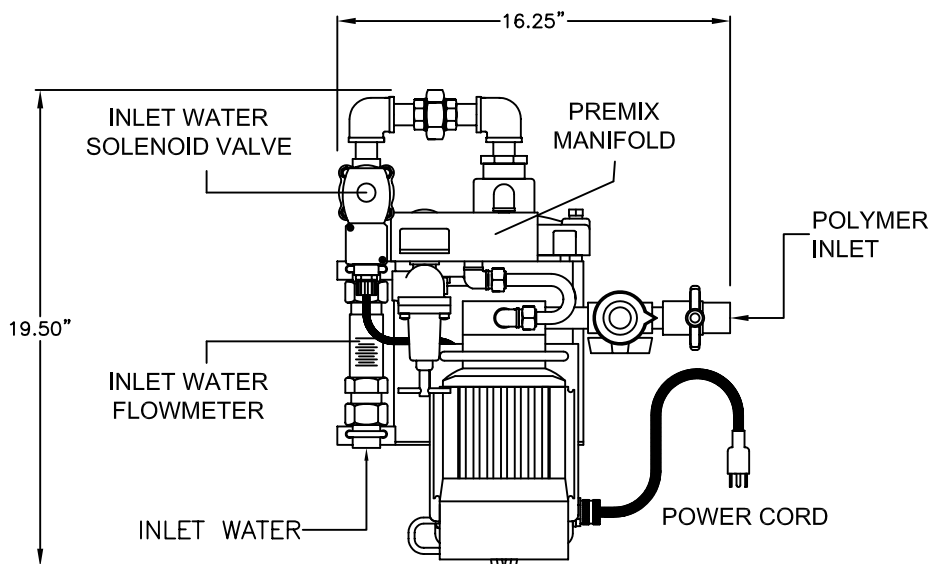

PLAN VIEW

NORCHEM INC.

PLAN & ELEVATION

SHARPSHOOTER

SHP_TYP_MTG

(TYPICAL INSTALLATION DIMENSIONS)

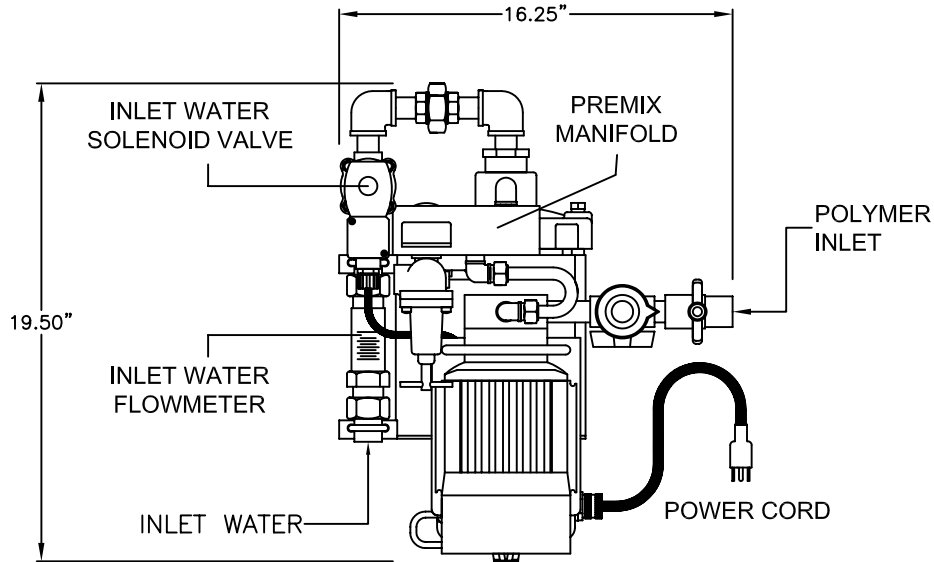

PLAN VIEW

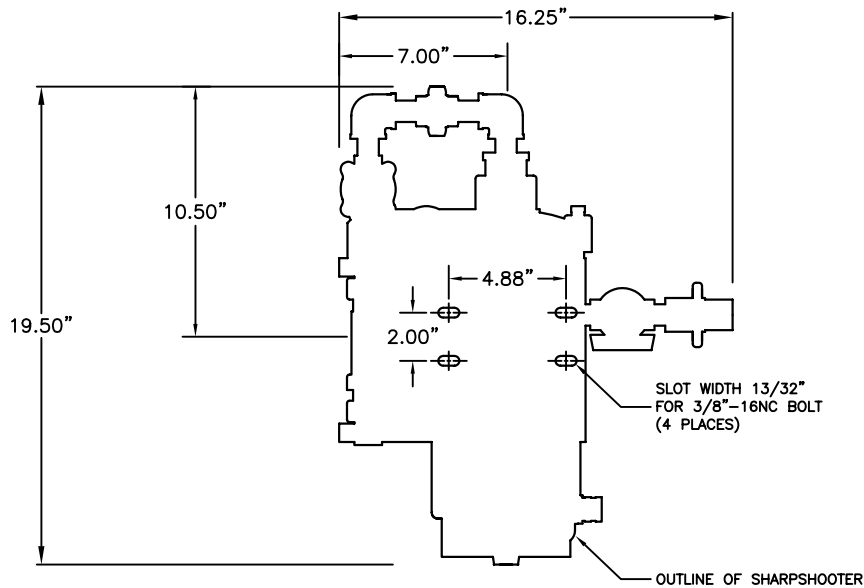

MOUNTING DETAIL

NORCHEM INC.

ELECTRICAL SCHEMATIC

SHARPSHOOTER

SHP_ELE

(TYPICAL TO ALL SHARPSHOOTER SYSTEMS)

INCOMING POWER
115 VAC/1 PH/60 HZ

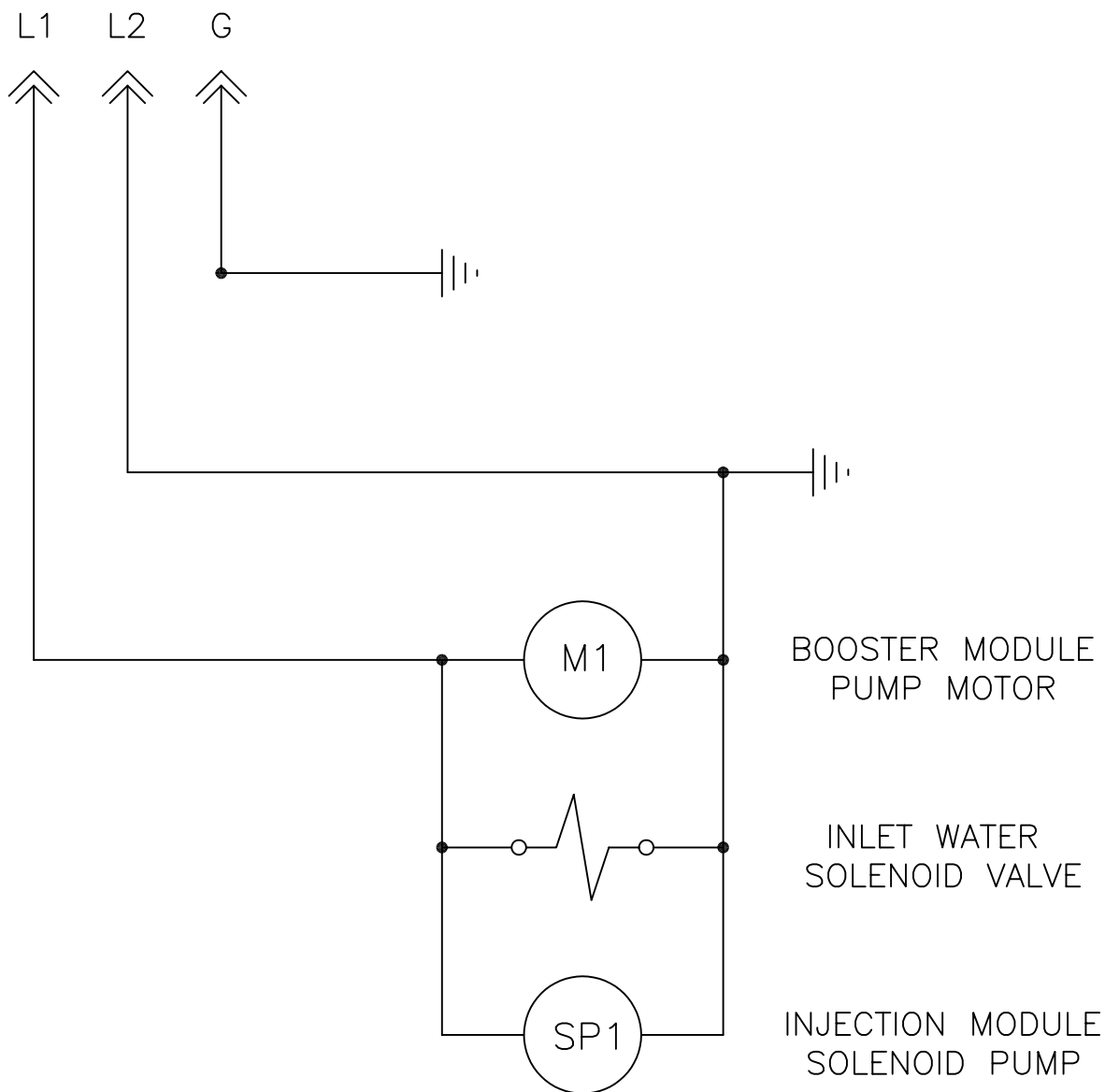

NORCHEM INC.

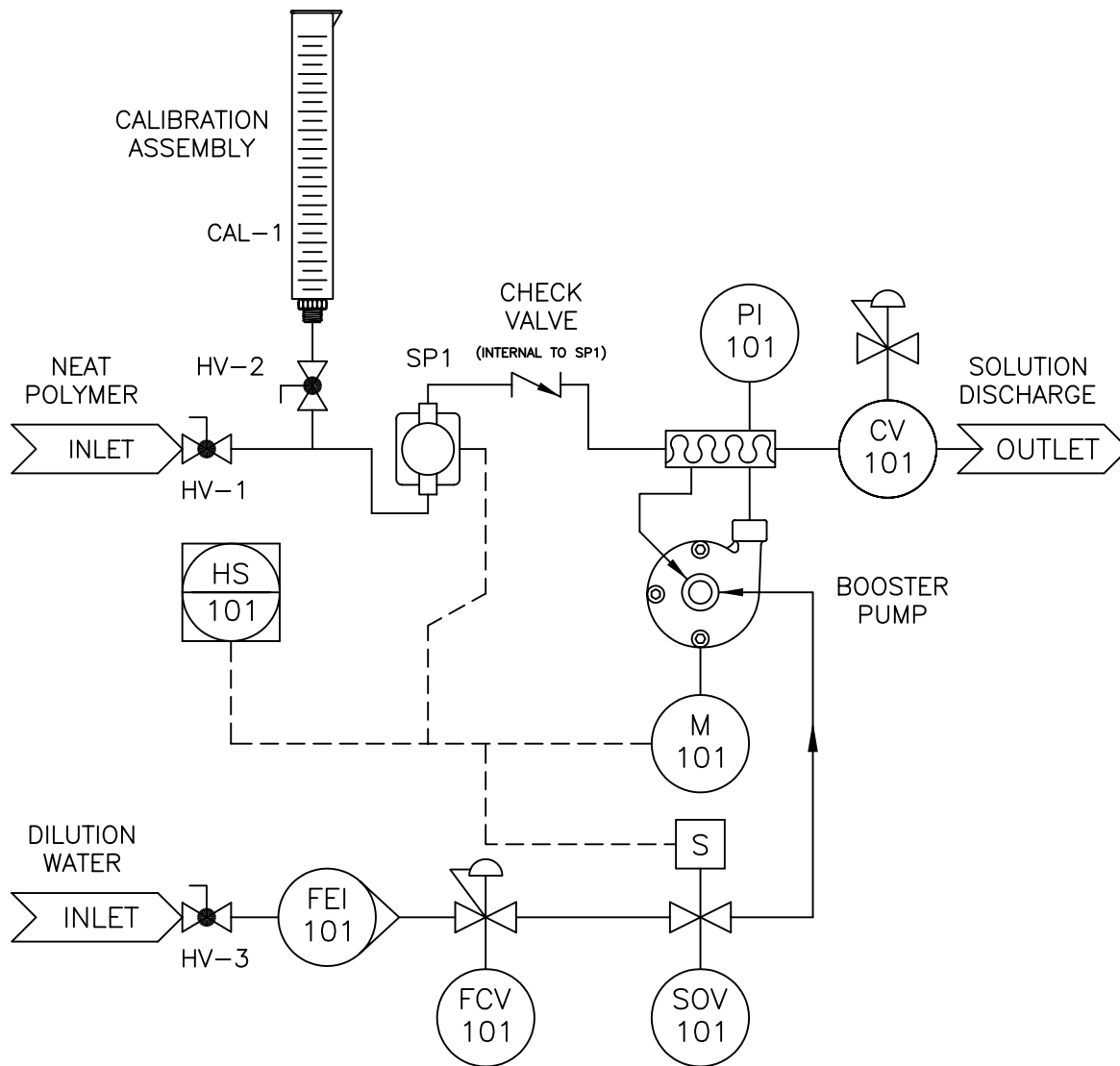

LEGEND

- | | |
|---------|---|
| HV-1 | POLYMER SUPPLY SHUTOFF HAND VALVE |
| HV-2 | CALIBRATION ASSEMBLY ISOLATION HAND VALVE |
| HV-3 | INLET WATER THROTTLING VALVE |
| CAL-1 | CALIBRATION CYLINDER |
| PI-101 | MIXING PRESSURE GAUGE |
| SP1 | INJECTION MODULE SOLENOID PUMP w/INTERNAL CHECK VALVE |
| M-101 | BOOSTER PUMP MOTOR |
| SOV-1 | DILUTION WATER INLET SOLENOID VALVE |
| CV-101 | MIXING PRESSURE CONTROL VALVE |
| FEI-101 | DILUTION WATER INDICATING FLOW METER |
| FCV-101 | DILUTION WATER FLOW CONTROL REGULATOR |
| HS-101 | OFF/ON SWITCH |